

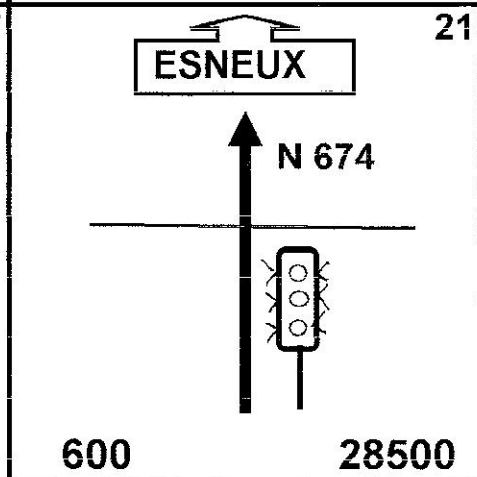

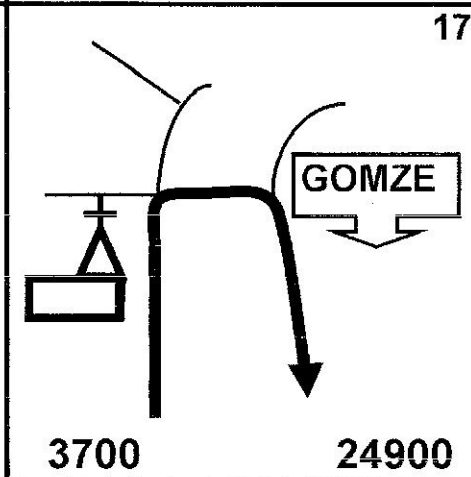

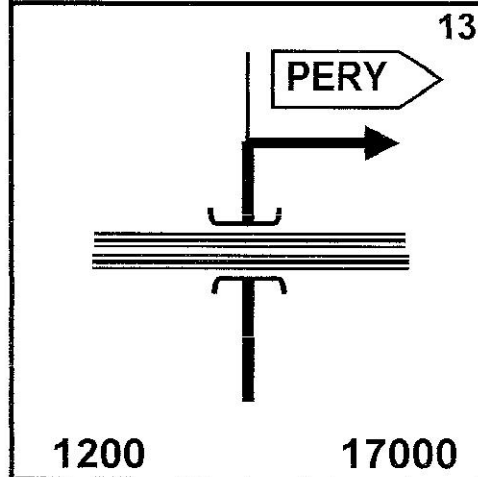

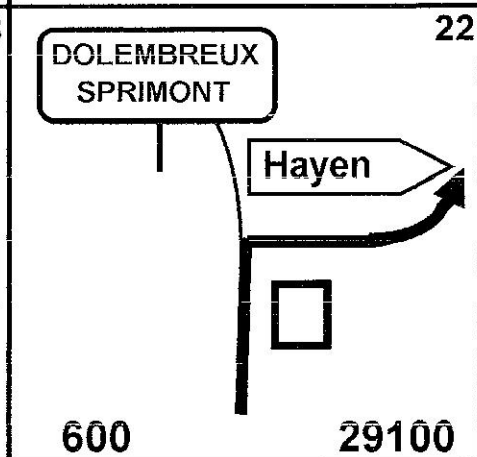

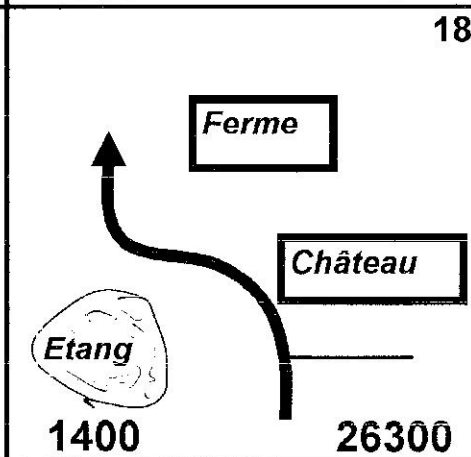
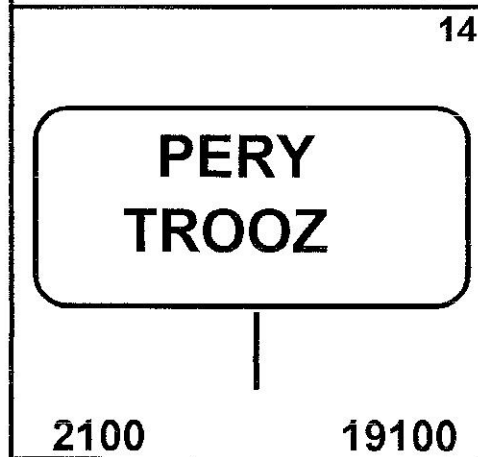
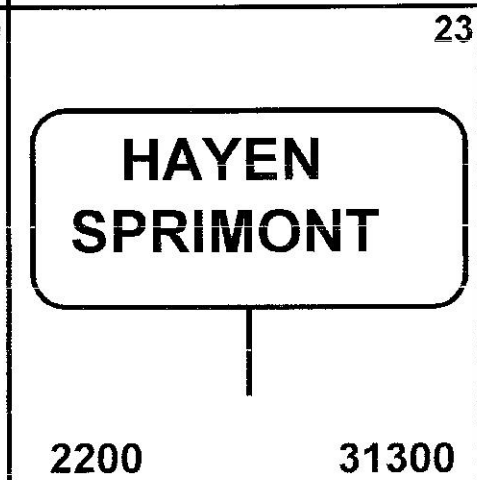
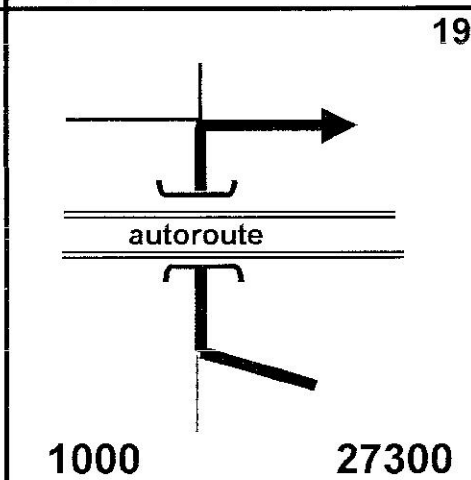
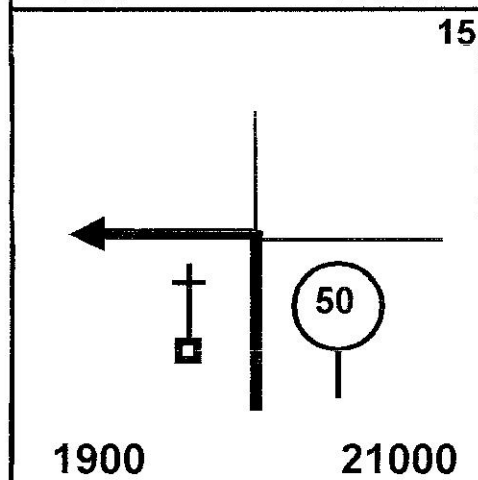
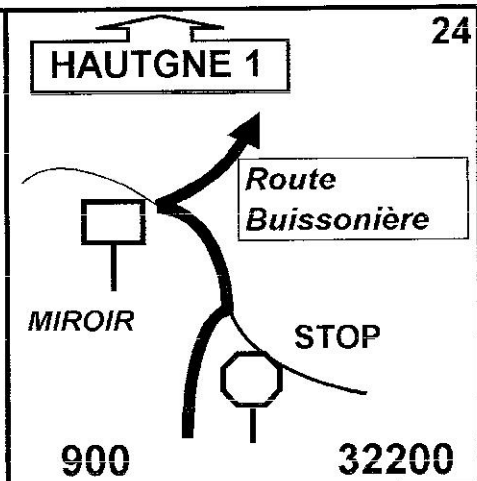
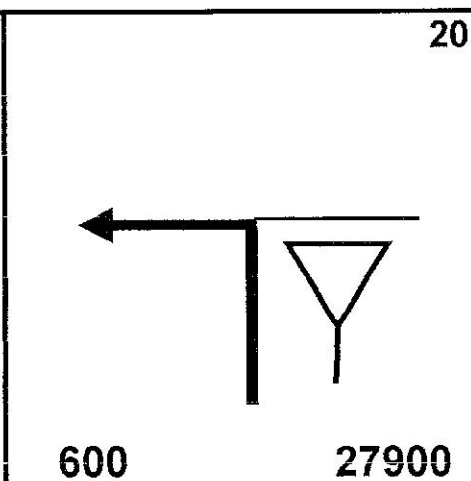
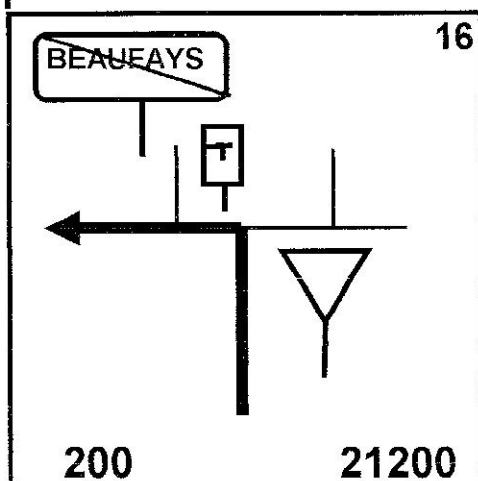





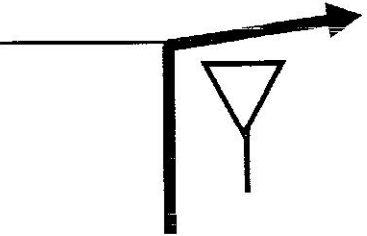

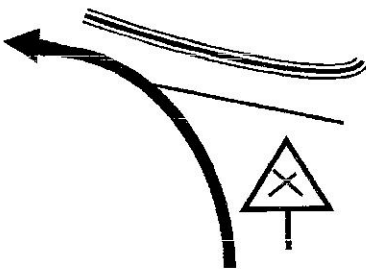

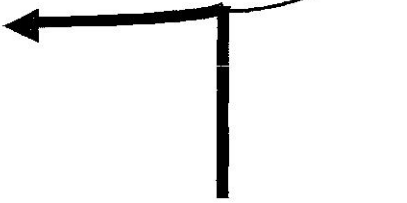





<p>4</p> <p>1400 5400</p>	<p>8</p> <p>1900 10000</p>	<p>12</p> <p>400 15800</p>
<p>3</p> <p>3300 4000</p>	<p>7</p> <p>500 8100</p>	<p>11</p> <p>3100 15400</p>
<p>2</p> <p>700 700</p>	<p>6</p> <p>200 7600</p>	<p>10</p> <p>1300 12300</p>
<p>1</p>	<p>5</p> <p>2000 7400</p>	<p>9</p> <p>1000 11000</p>



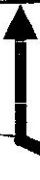

<p>28</p> <p>1500 36600</p>	<p>32</p> <p>3200 43800</p>	<p>36</p> <p>200 49200</p>
<p>27</p> <p>500 35100</p>	<p>31</p> <p>400 40600</p>	<p>35</p> <p>1000 49000</p>
<p>26</p> <p>1000 34600</p>	<p>30</p> <p>1700 40200</p>	<p>34</p> <p>2900 48000</p>
<p>25</p> <p>1400 33600</p>	<p>29</p> <p>1900 38500</p>	<p>33</p> <p>1300 45100</p>



<p>40</p>   <p>1200 54800</p>	<p>44</p>  <p>800 3300</p>	<p>48</p>   <p>300 8500</p>
<p>39</p>   <p>1500 53600</p>	<p>43</p>  <p>2500 2500</p>	<p>47</p>  <p>2500 8200</p>
<p>38</p> <p>Miroir</p>    <p>600 52100</p>	<p>42</p>    <p>Remise des compteurs à zéro</p>	<p>46</p>     <p>500 5700</p>
<p>37</p>  <p>2300 51500</p>	<p>41</p> <p>Arrêt graissage au café du TULTAY Grand Route n°3 4163 TAVIER 0475 36 67 36 04 246 91 16</p> <p>600 55400</p>	<p>45</p>     <p>1900 5200</p>



52

**VIEN**

1000

13100

56

**R.S.P.  
sur 4 Km.  
Suivre  
POULSEUR**

60

Remise des compteurs à zéro

*Repas de midi à la  
salle des Sports,  
rue Esneux, 19b  
POULSEUR.  
Tél. 04 380 11 58  
Bon appétit.*

51

**ANTHISNES 4**

2900

12100

55

**POULSEUR**

Bus

Château

200

15600

59

**Arrêt de Midi**

Parking  
VOITURES

Salle  
des SPORTS

Parking  
MOTOS

400

22200

50

**OUFFET**

500

9200

54

**POULSEUR 6**

Bus

1300

15400

58

Grand  
place

Café  
JUPILER

2200

21800

49

Rue de  
HODY

Station  
ESSO

Bus

200

8700

53

**ANTHISNES 1**

1000

14100

57

50

**SART**

4000

19600



<p>64</p> <p>700 5600</p>	<p>68</p> <p>400 10200</p>	<p>72</p> <p>200 15800</p>
<p>63</p> <p>2900 4900</p>	<p>67</p> <p>500 9800</p>	<p>71</p> <p>3600 15600</p>
<p>62</p> <p>2000 2000</p>	<p>66</p> <p>1700 9300</p>	<p>70</p> <p>800 12000</p>
<p>61</p>	<p>65</p> <p>2000 7600</p>	<p>69</p> <p>1000 11200</p>

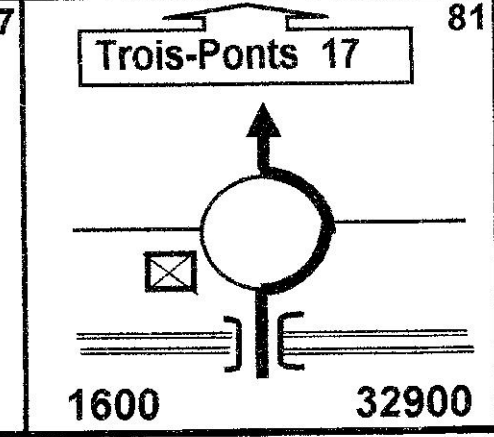
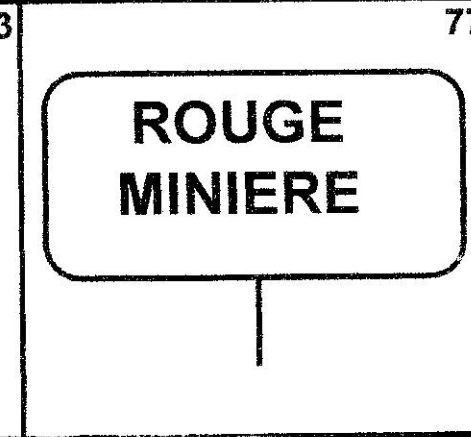
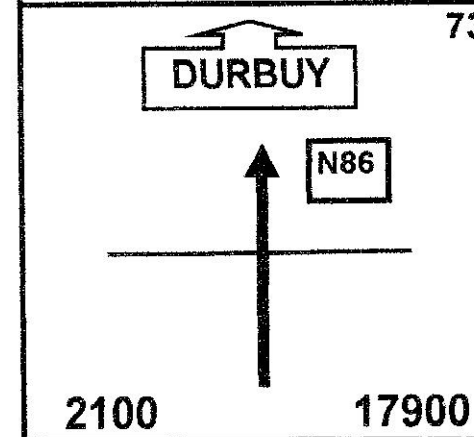
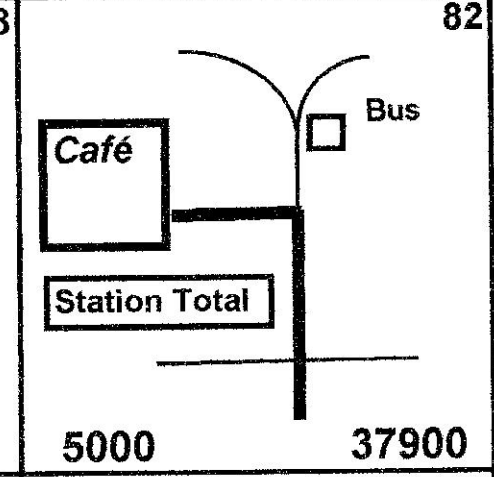
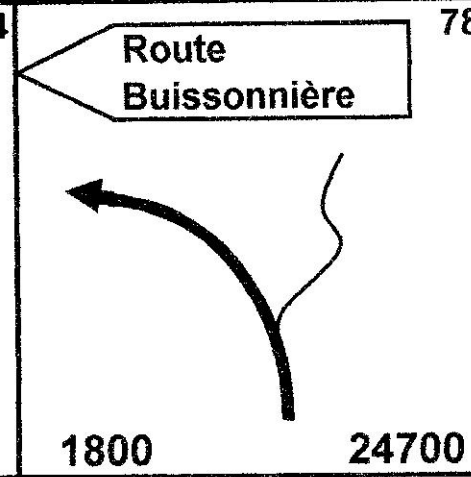
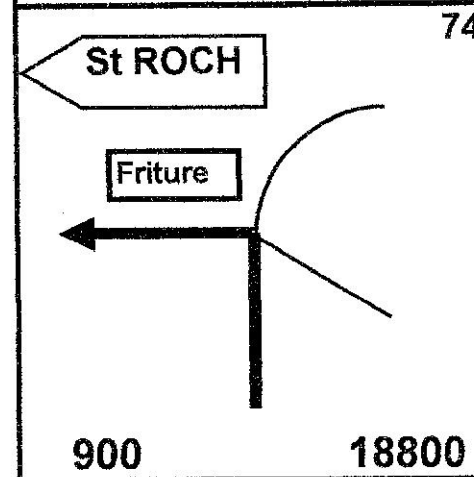
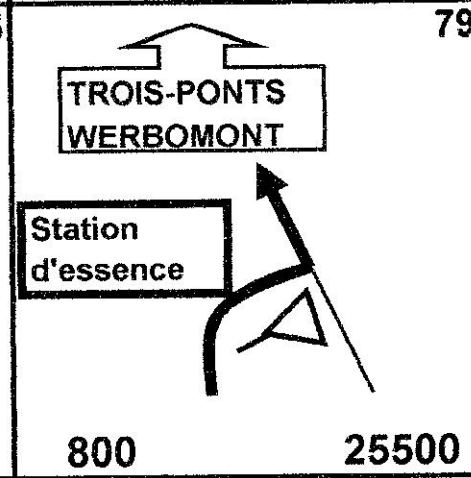
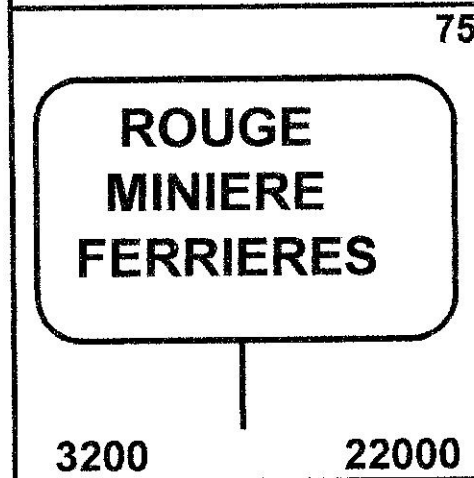
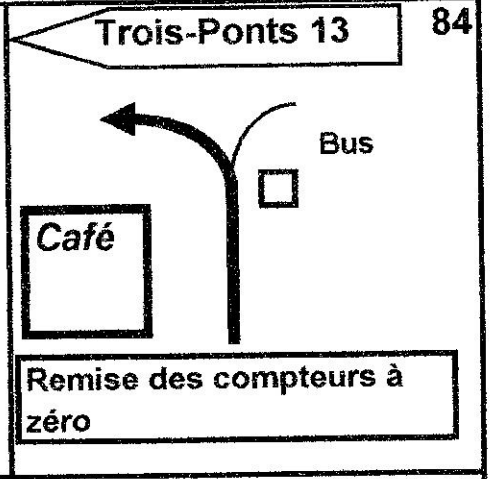
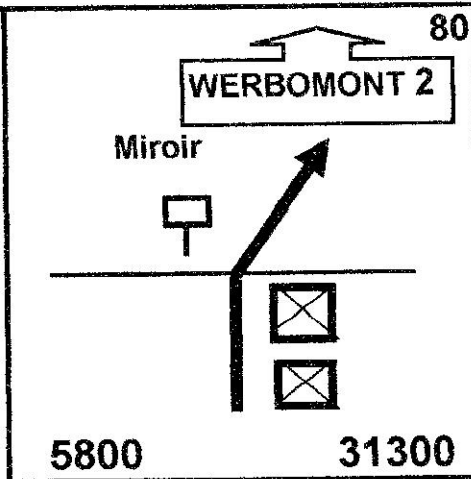
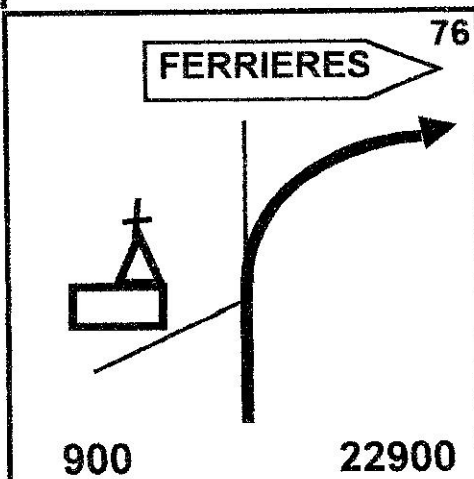



<p>88</p> <p><i>La Lienne</i></p> <p>1200      6600</p>	<p>92</p> <p>LORCE</p> <p>BRU CHEVRON</p> <p>5500      15600</p>	<p>96</p> <p>3000      25400</p>
<p>87</p> <p>Moulin RAHIER</p> <p>200      5400</p>	<p>91</p> <p>Miroir</p> <p>BRU CHEVRON</p> <p>600      10100</p>	<p>95</p> <p>PAVILLONCHAMPS</p> <p>800      22400</p>
<p>86</p> <p>NEUVILLE</p> <p>2500      5200</p>	<p>90</p> <p>300      9500</p>	<p>94</p> <p>1600      21600</p>
<p>85</p> <p>RAHIER 2</p> <p>2700      2700</p>	<p>89</p> <p>Miroirs</p> <p>Cimetière</p> <p>2600      9200</p>	<p>93</p> <p>HAVELANGE</p> <p>4400      20000</p>





<p>100</p> <p>ONEUX</p> <p>AWANS AYWAILLE</p> <p>400 28400</p>	<p>104</p> <p>Rue Rabohaye</p> <p>Miroir</p> <p>1800 34100</p>	<p>108</p> <p>LOUVEIGNE 5</p> <p>Bus</p> <p>900 36900</p>
<p>99</p> <p>Miroir</p> <p>Bus</p> <p>2300 28000</p>	<p>103</p> <p>300 32300</p>	<p>107</p> <p>400 36000</p>
<p>98</p> <p>Cimetière</p> <p>200 25700</p>	<p>102</p> <p>MARTINRIVE</p> <p>STOP</p> <p>2400 32000</p>	<p>106</p> <p>Rue ROUVREUX</p> <p>Miroir</p> <p>1300 35600</p>
<p>97</p> <p>100 25500</p>	<p>101</p> <p>CHAMBRALLES</p> <p>1200 29600</p>	<p>105</p> <p>200 34300</p>

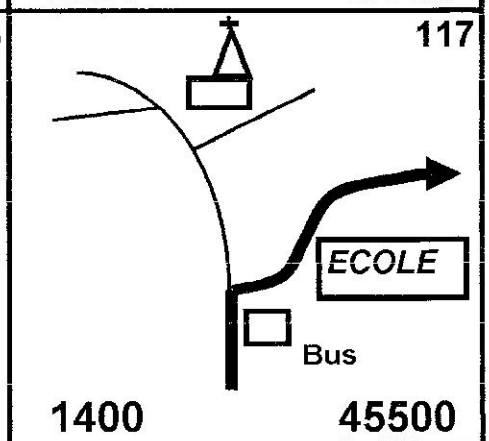
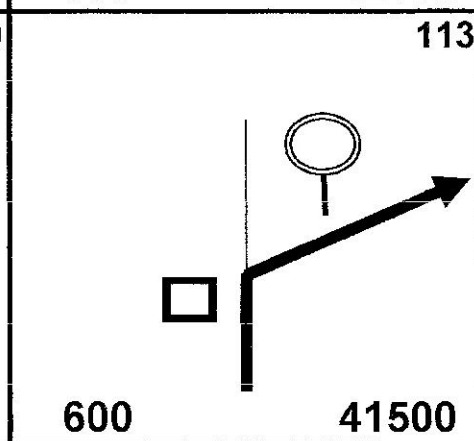
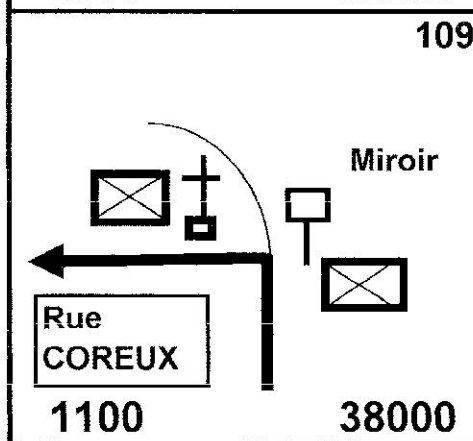
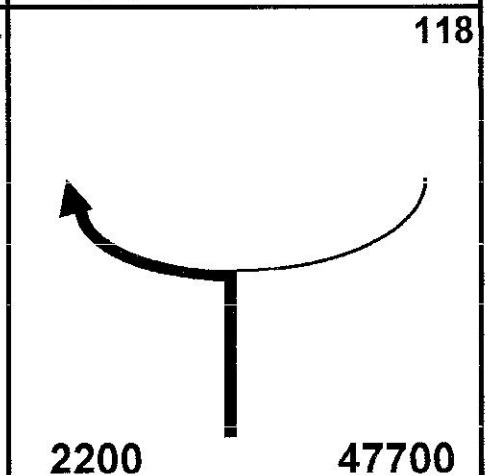
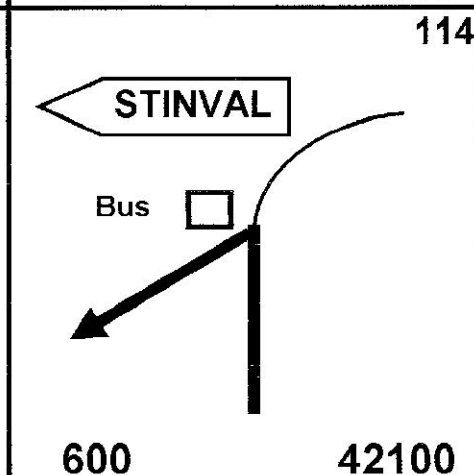
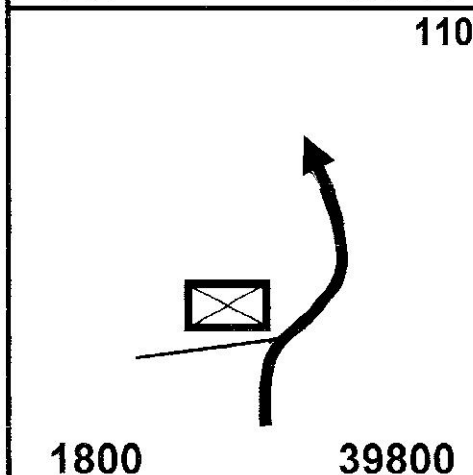
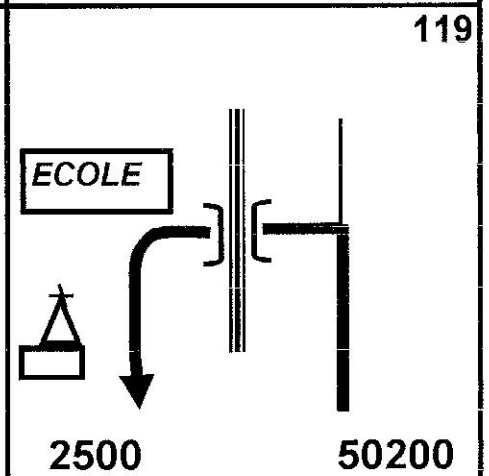
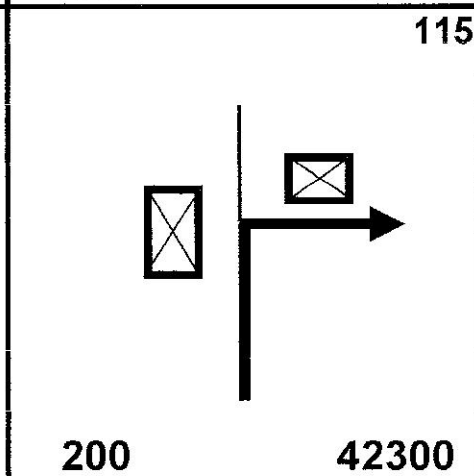
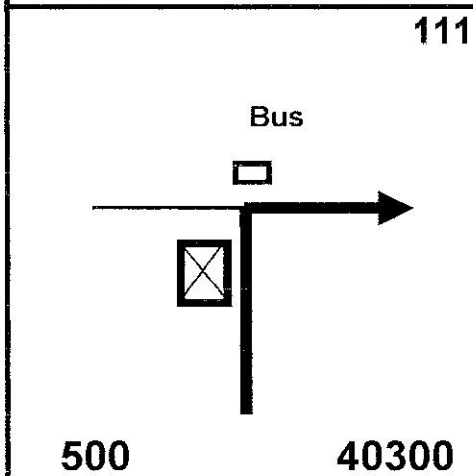
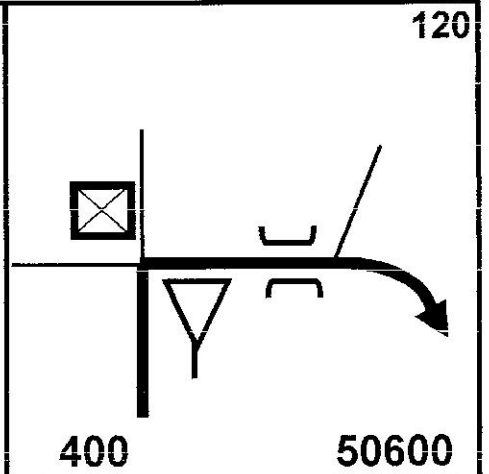
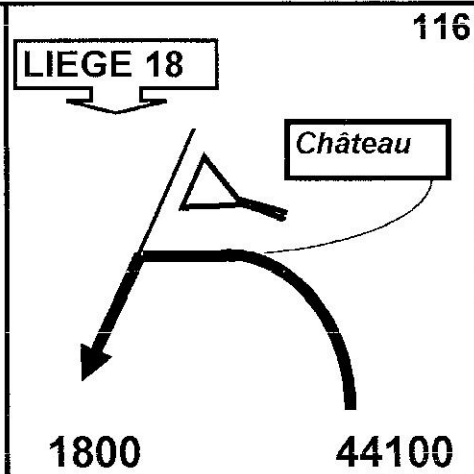
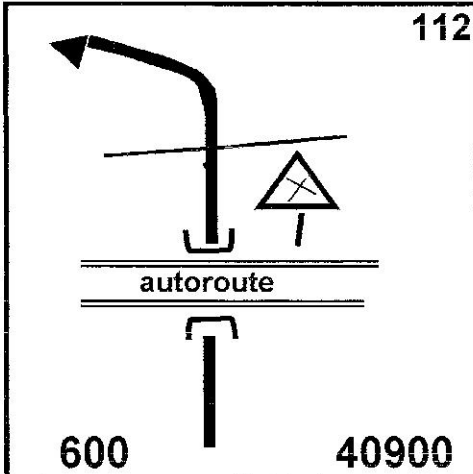



124

**R.S.P.  
SOUMAGNE  
BAS  
3,100 km.**

Merci pour votre participation à la balade réalisée au profit des enfants de "La Court' Echelle"

123

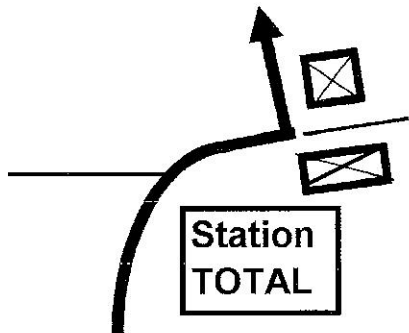

3200

53300

127

Arrivée au  
**PARKING**

700

61400

122

**R.S.P.  
OLNE  
3,200 km.**

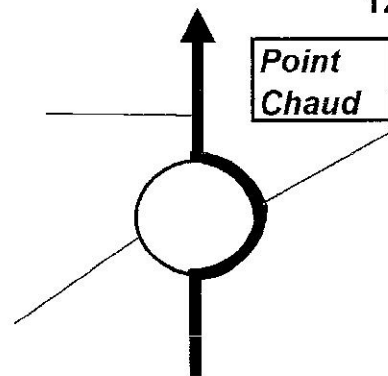

4600

60700

126

121

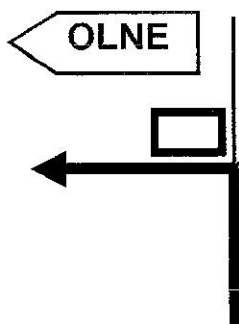

1700

52300

125

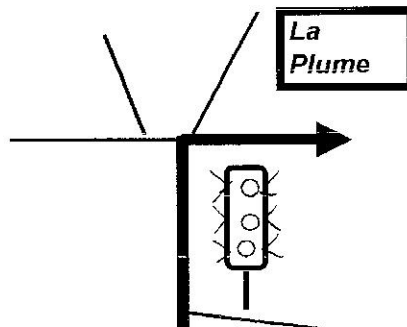

3100

56100

Rendez-vous le 8 avril (dimanche de Pâques) rue des Ecoles à HERVE pour la Balade Pascale.